



zenika

<animés par la passion>

CODING
THE WORLD

SCHÉMA GLOBAL

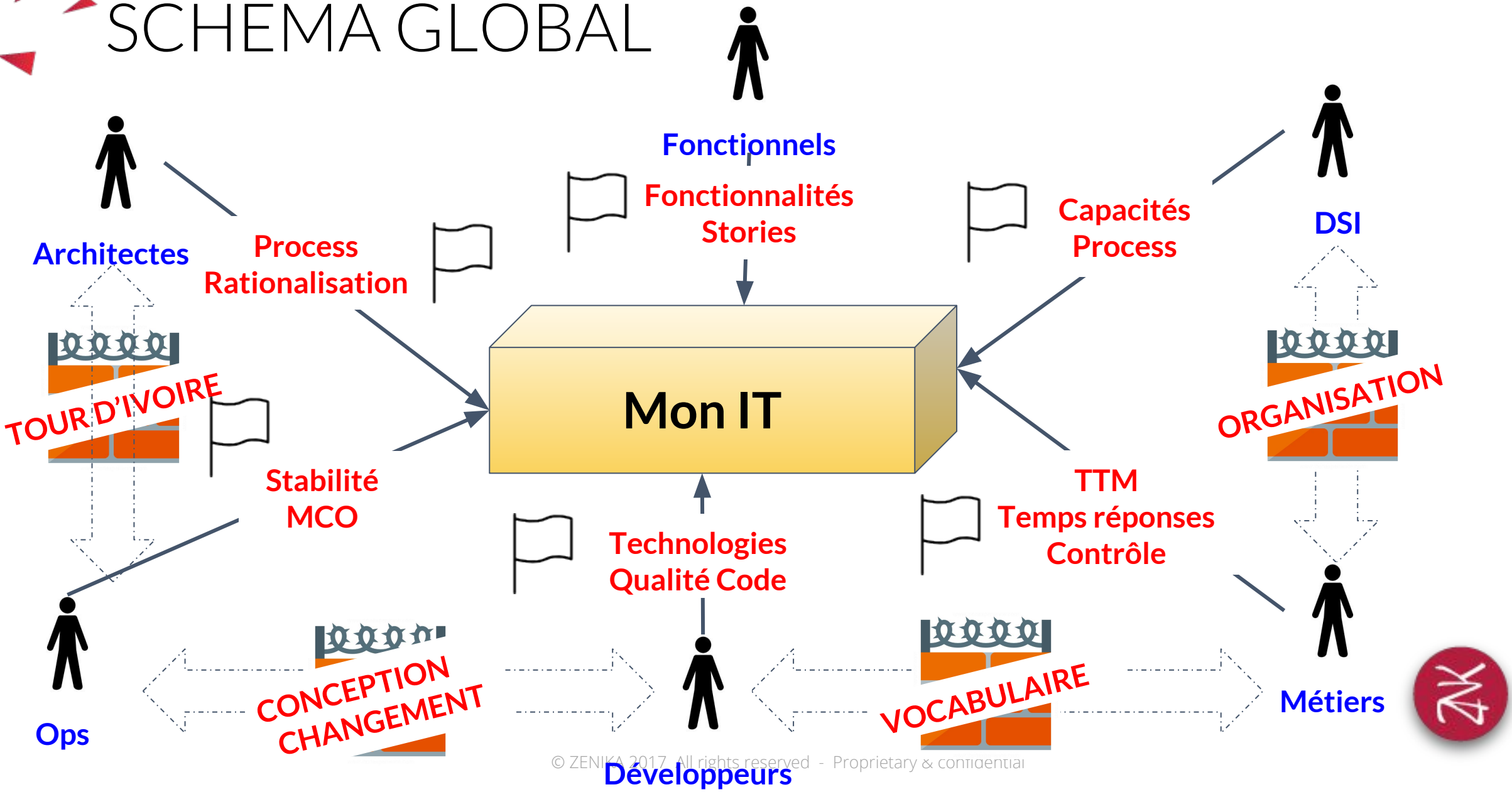



ARCHITECTE 3.0



LE CASE

AGENCE DE VOYAGES

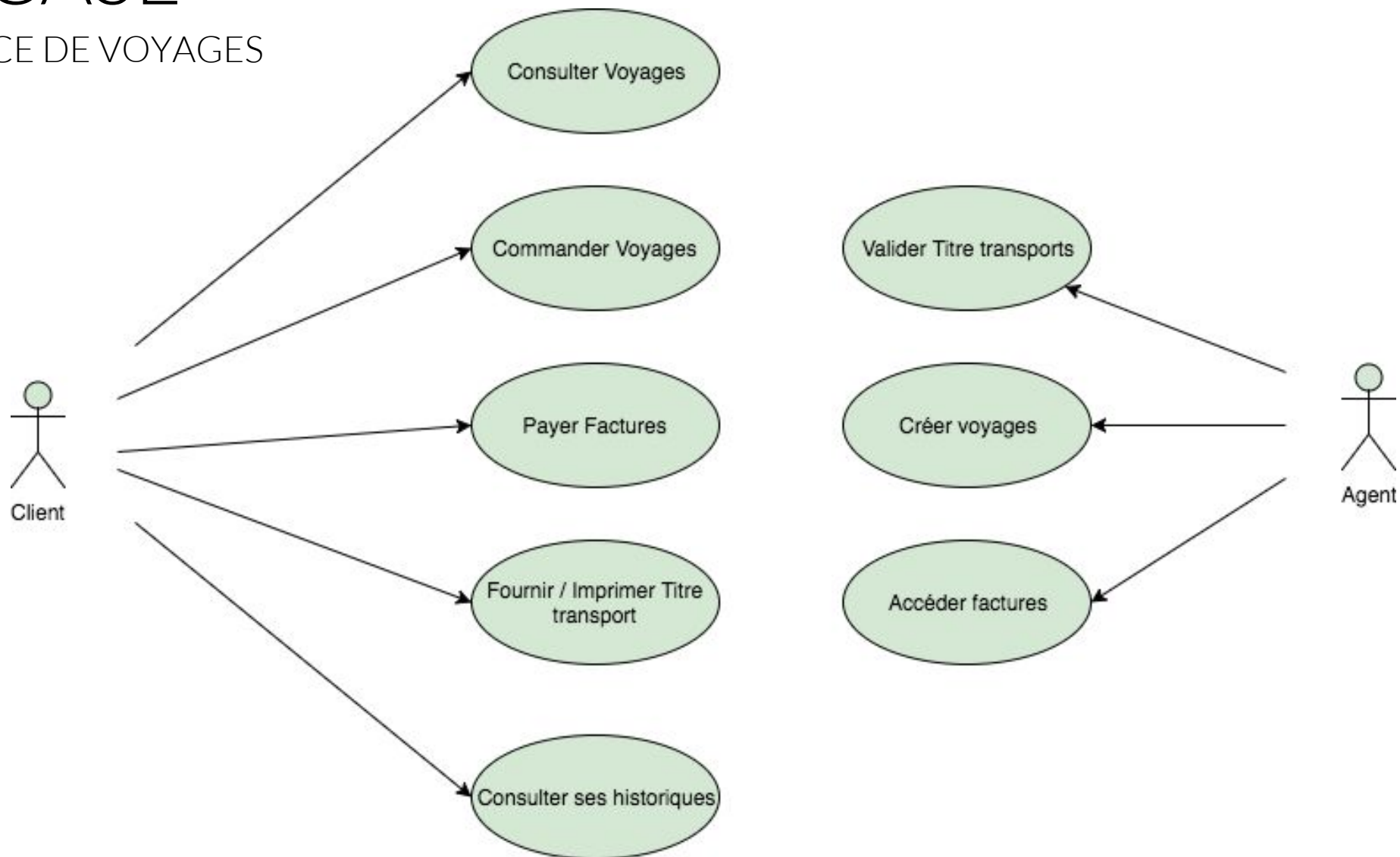

LE CASE

AGENCE DE VOYAGES

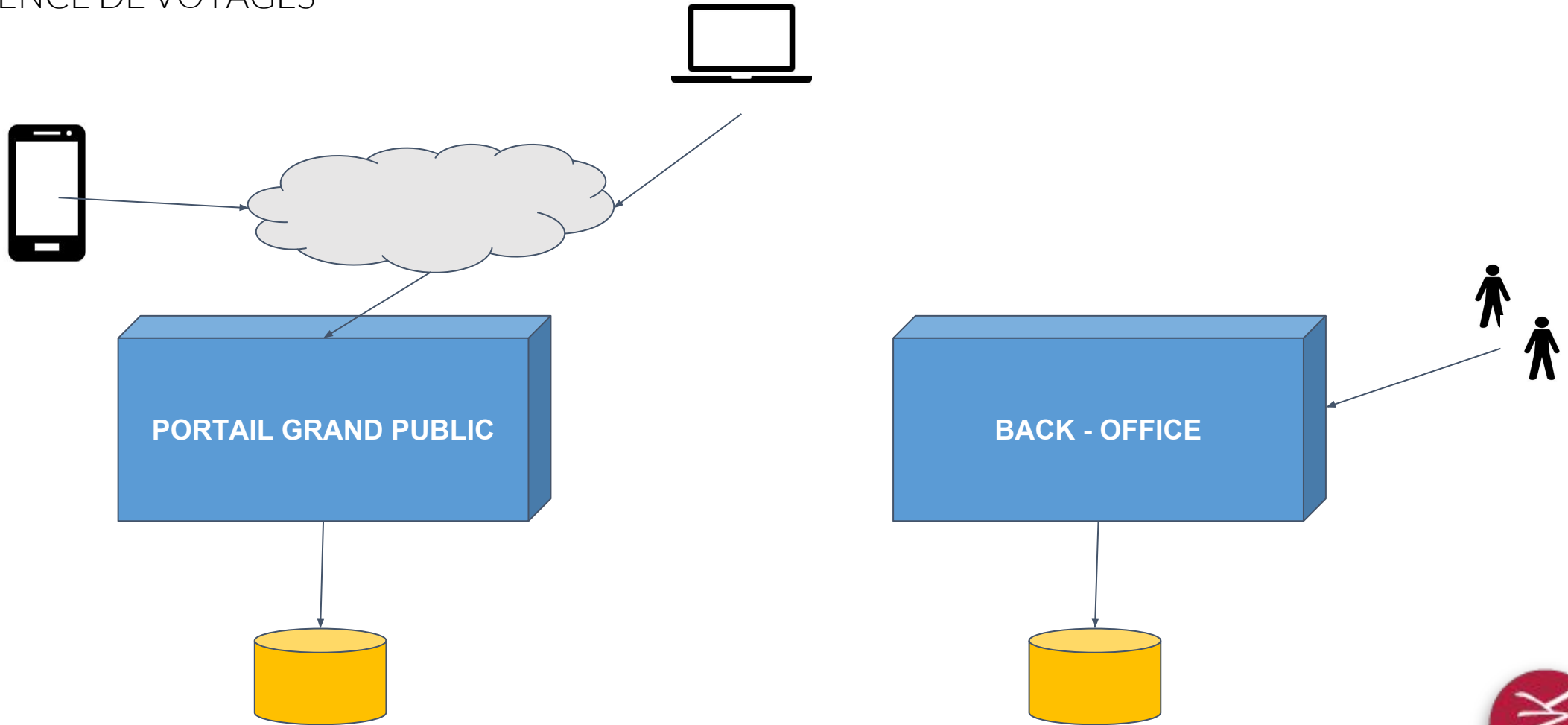



REPRÉSENTATION DU SYSTÈME

- UML
- TOUR D'IVOIRE

Simon Brown :

- représenter un système
 - piste d'atterrissage
 -
- UML compliqué et peu efficient :
 - difficile à mettre à jour
 - manque de compréhension des acteurs
 - lien entre les vues (4+1 / RUP)



UML

DIAGRAMME DE COMPOSANTS

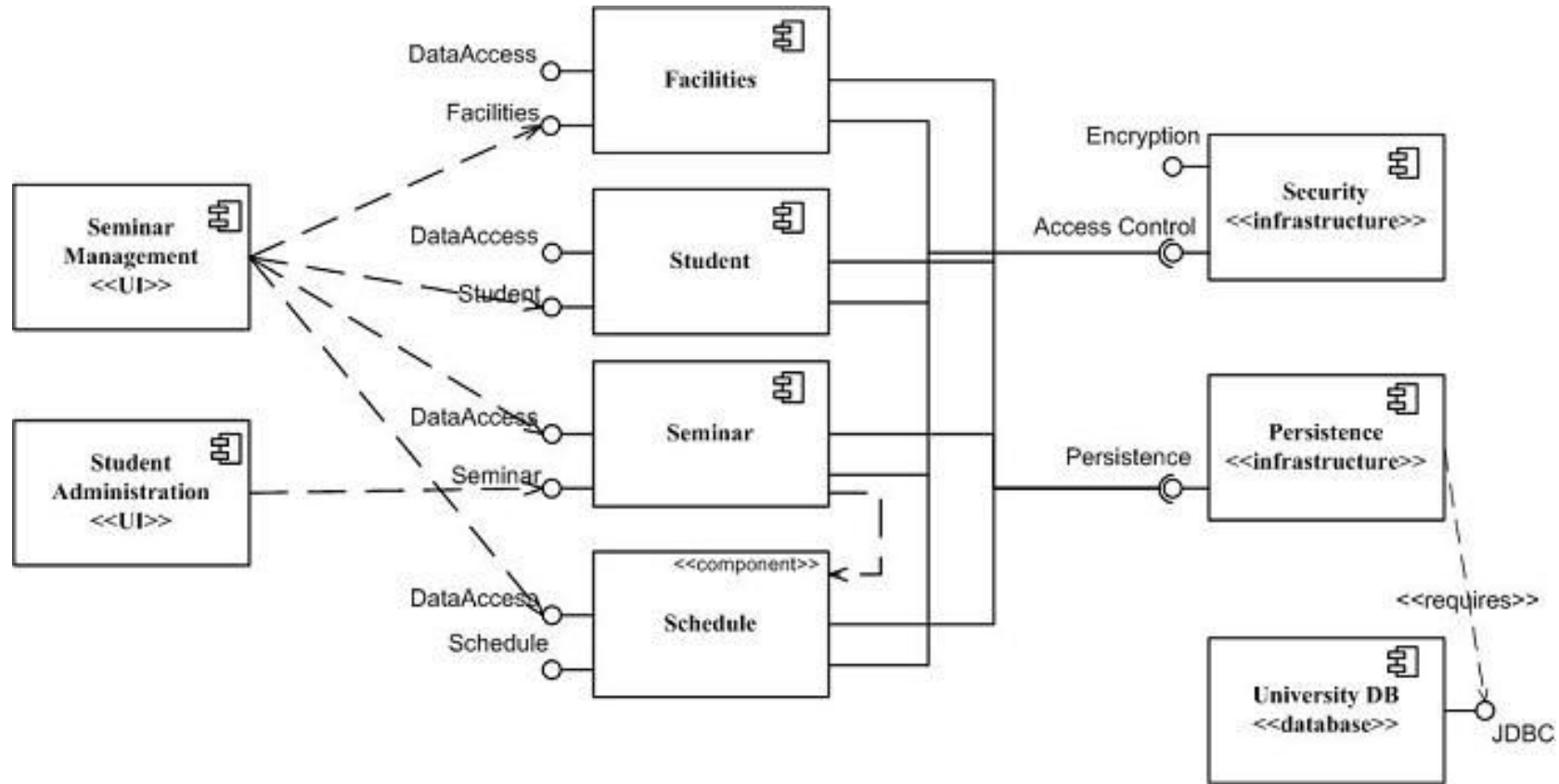

ARCHITECTES LOGICIELS

VISION D'ENSEMBLE SUR LE SYSTÈME

Diagrammes C4 (Simon Brown)

- Diagramme de contexte
- Diagramme de conteneurs
- Diagramme de composants
- Diagramme de classe



SCHÉMA GLOBAL





AGILISTE

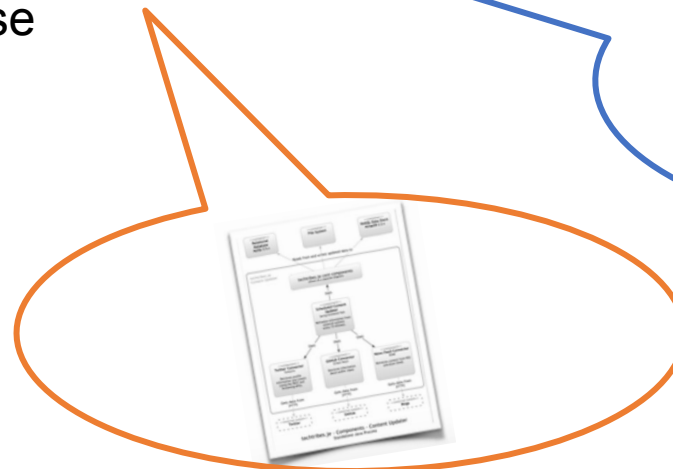
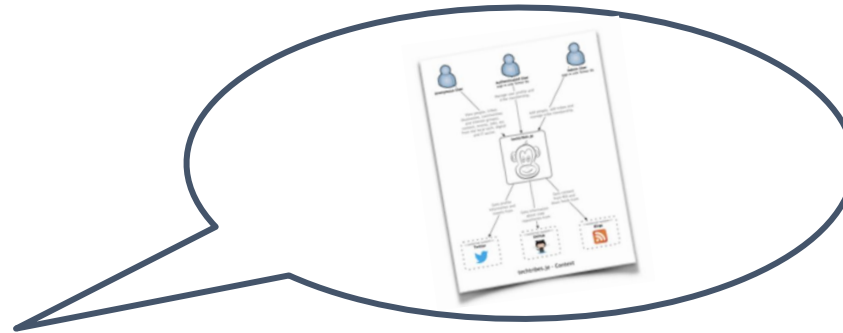
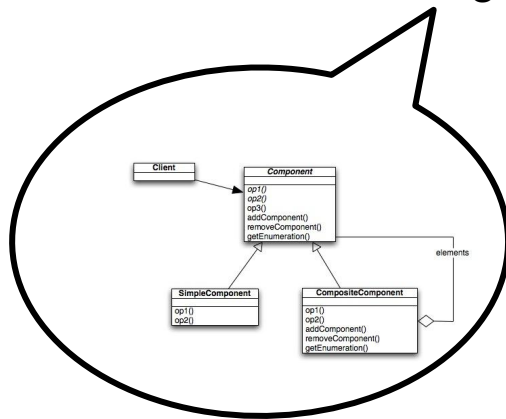
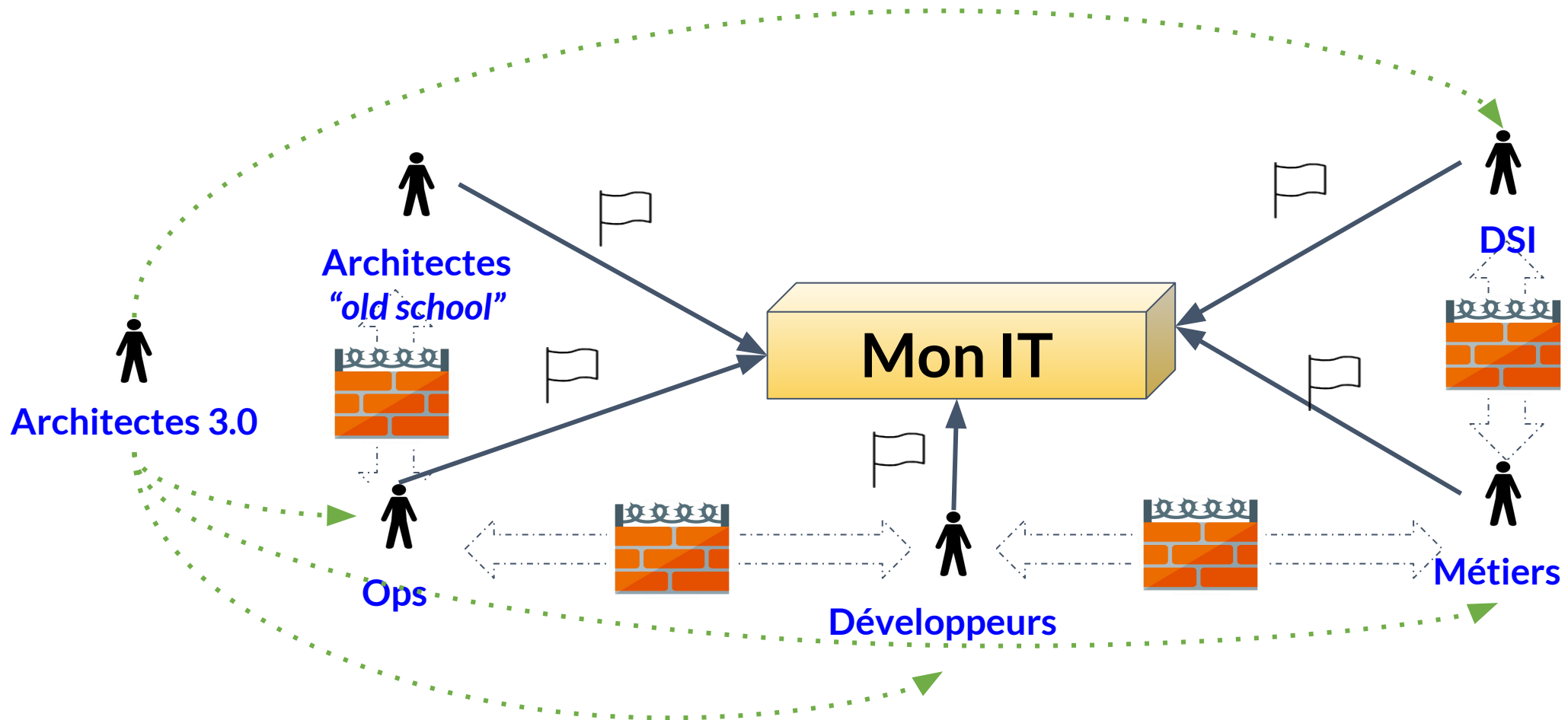

AGILISTE

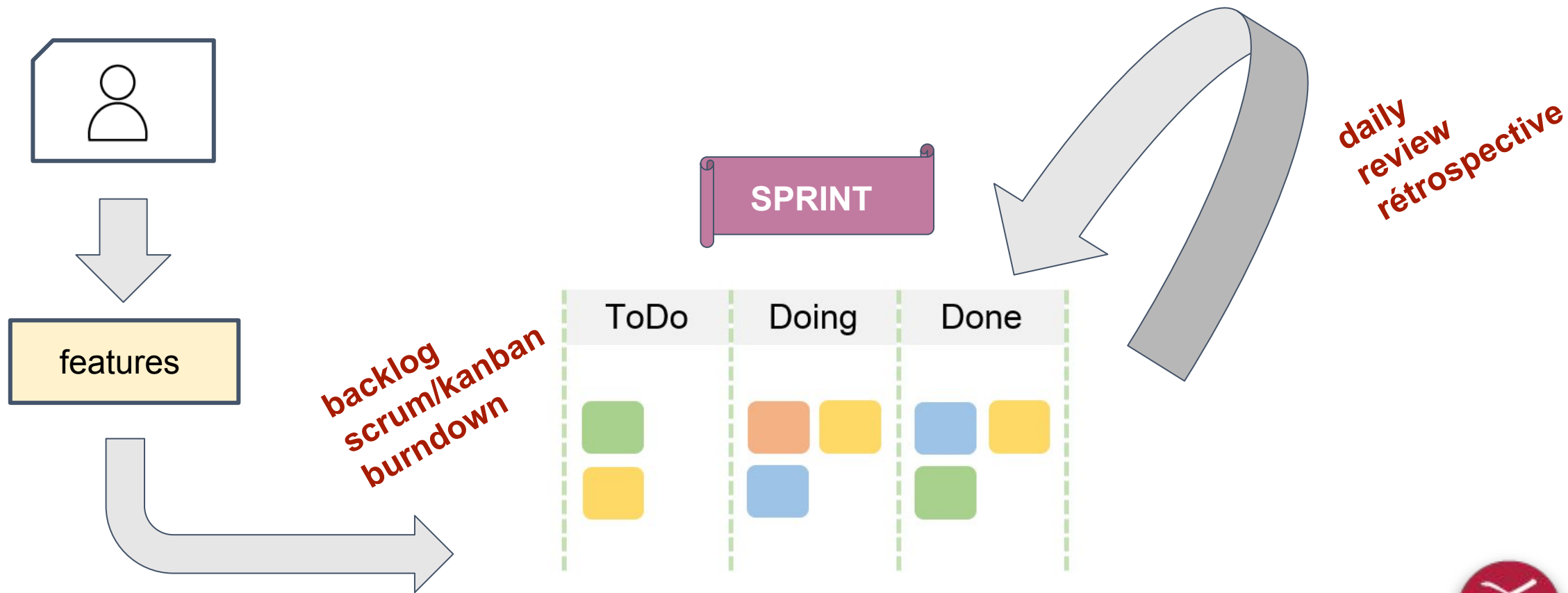

AGILISTE

STORY MAPPING

	Sujet 1	Sujet 2	Sujet 3	Sujet 4	Sujet 5	Sujet 6
Court terme	Sujet {Indicateurs} {enablers}	Sujet {Indicateurs} {enablers}	Sujet {Indicateurs} {enablers}	Sujet {Indicateurs} {enablers}	Sujet {Indicateurs} {enablers}	Sujet {Indicateurs} {enablers}
Moyen terme	Sujet {Indicateurs} {enablers}	Sujet {Indicateurs} {enablers}	Sujet {Indicateurs} {enablers}	Sujet {Indicateurs} {enablers}	Sujet {Indicateurs} {enablers}	Sujet {Indicateurs} {enablers}
Long terme	Sujet {Indicateurs} {enablers}	Sujet {Indicateurs} {enablers}	Sujet {Indicateurs} {enablers}	Sujet {Indicateurs} {enablers}	Sujet {Indicateurs} {enablers}	Sujet {Indicateurs} {enablers}



Minimum Viable Product (MVP) (Eric RIES)

Le produit le plus simple possible répondant à un objectif minimum pour lequel un client est prêt à payer (ou à en mesurer la valeur)



SCHÉMA GLOBAL





DEVOPS

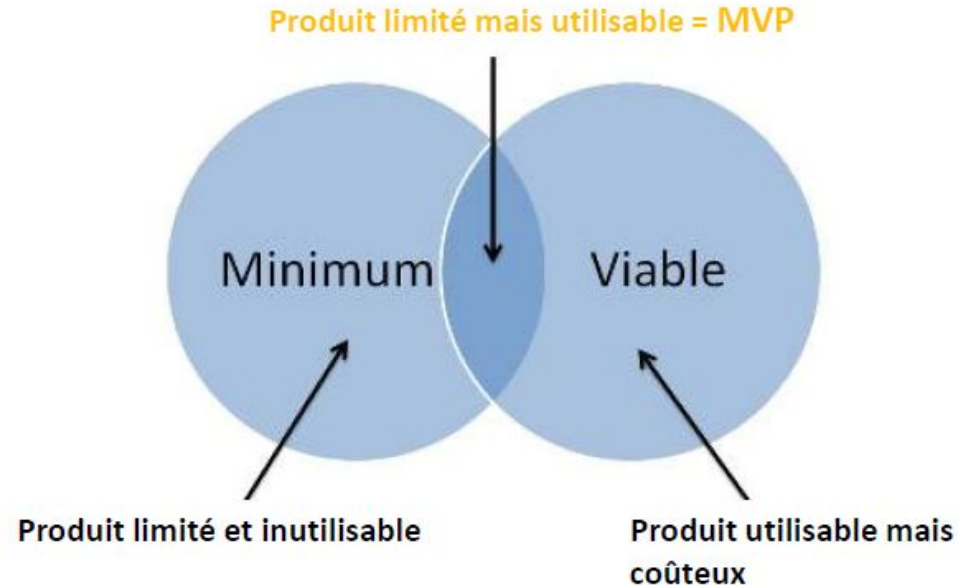
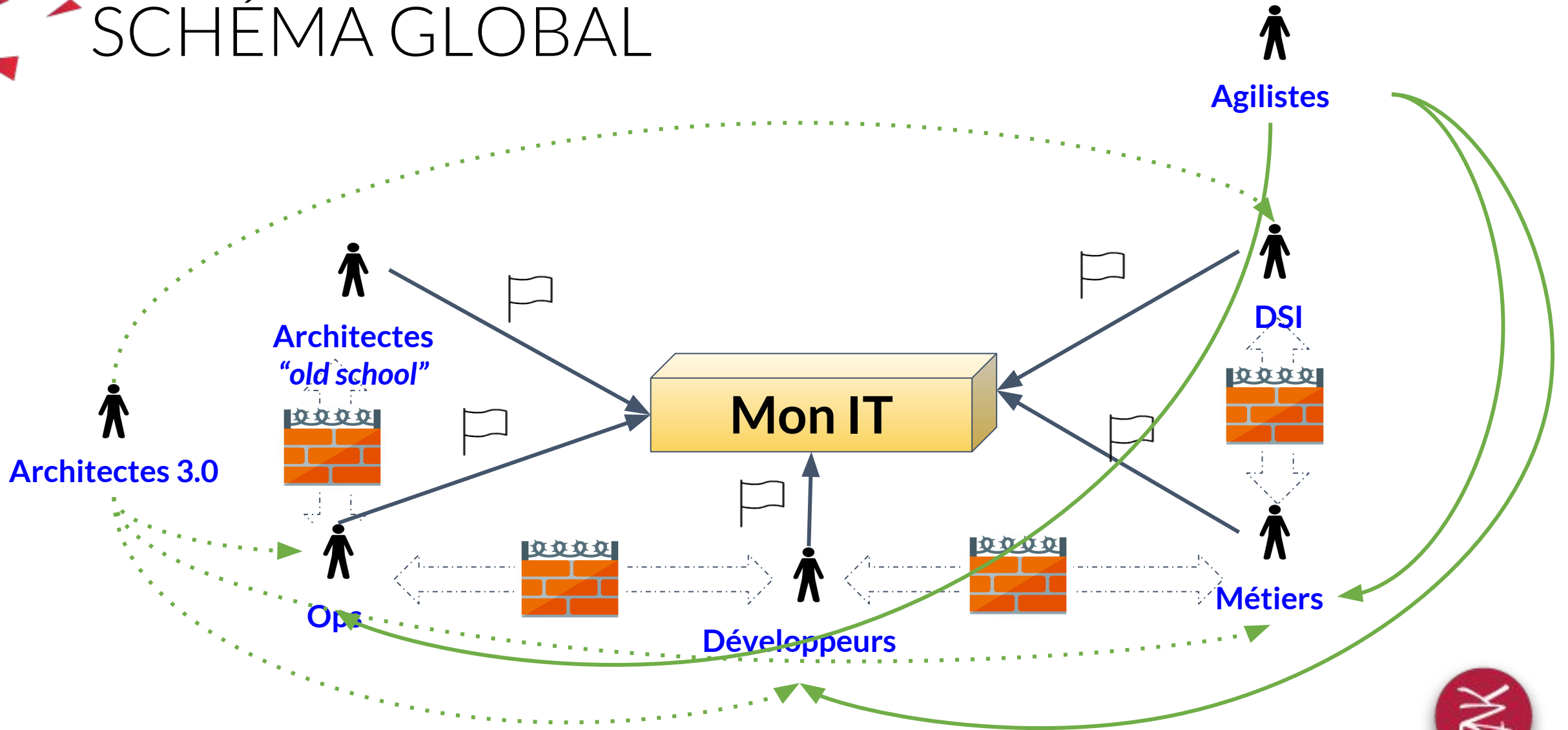

SCHÉMA GLOBAL

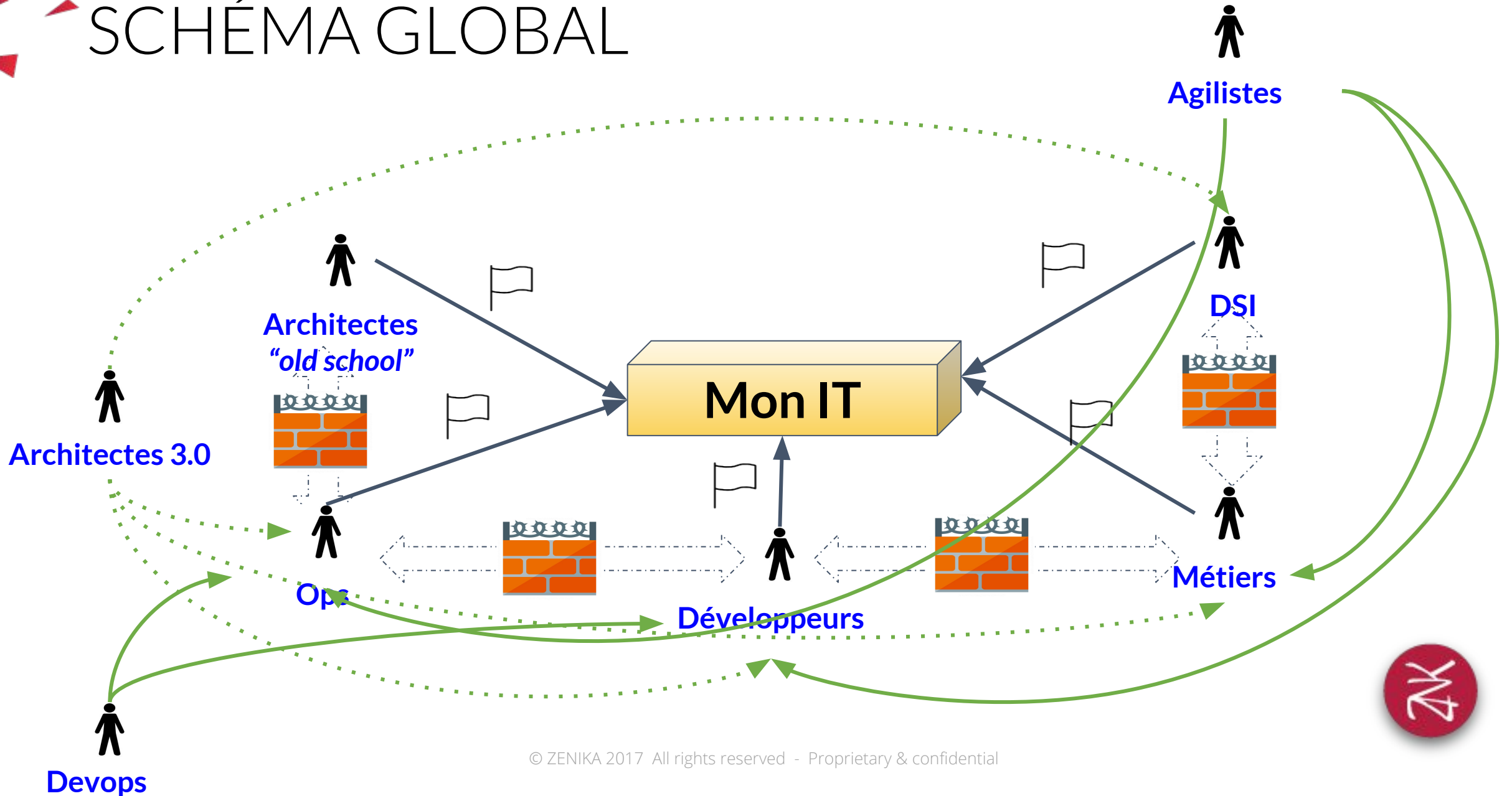



zenika

<animés par la passion>

MERCI

www.zenika.com

blog.zenika.com



info@zenika.com

01 45 26 19 15

RUP

Iterative Development

Business value is delivered incrementally in time-boxed cross-discipline iterations.

